

Canon



Photo All-In-One
PIXMA MP640 series

Getting Started

Read Me First

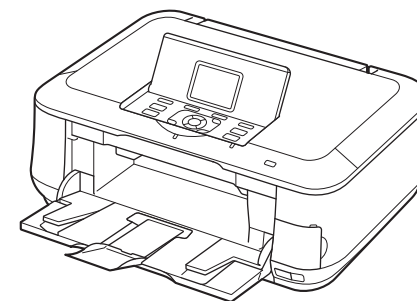

Make sure to read this manual before using the machine. Please keep it in hand for future reference.



■ Symbols Used in This Document



Instructions including important information. Be sure to read these indications.



Instructions as notes for operation or additional explanations.



Descriptions for operations that take some time to complete.



Indicates operations in Windows.



Indicates operations in Macintosh.

- Microsoft is a registered trademark of Microsoft Corporation.
- Windows is a trademark or registered trademark of Microsoft Corporation in the U.S. and/or other countries.
- Windows Vista is a trademark or registered trademark of Microsoft Corporation in the U.S. and/or other countries.
- Internet Explorer is a trademark or registered trademark of Microsoft Corporation in the U.S. and/or other countries.
- Macintosh, Mac, and AirPort are trademarks of Apple Inc., registered in the U.S. and other countries.
- Bonjour is a trademark of Apple Inc., registered in the U.S. and other countries.

Contents

Preparation	2	Network Connection	20
Preparation	2	Select Connection Type	20
Devices Required to Connect to Computers	2	Notes on Network Connection	20
Check the Included Items	3	Wireless Setup	22
Hardware Setup	4	Check the Information for Wireless Connection	22
Turn the Power On	4	Wireless Setup Using WPS (Wi-Fi Protected Setup) ..	26
Install the Print Head	5	Wired Setup	29
Install the Ink Tanks	8	Confirm Connection Status	32
Align the Print Head	11	Install the Software	34
Select Connection Method	13	Install the Software (Registration)	41
Select Connection Method	13	Install the Software (Information)	45
USB Connection	14	After Installing the Machine	47
Install the Software	14	Loading Paper	47
		Introduction of Manuals	50
		Solution Menu	51
		Try Using the Machine	52
		Print Photos from a Memory Card	53
		Try Copying	56
		Print Photos from a Computer	57
		Reference Information	58
		Wireless Setup Using WCN (Windows Connect Now)	58

Preparation

■ Devices Required to Connect to Computers

USB Connection

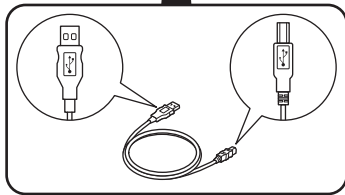
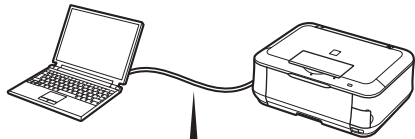

USB cable

A USB cable is required.

Network Connection

Wireless Connection

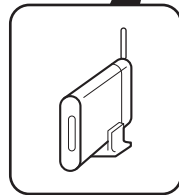
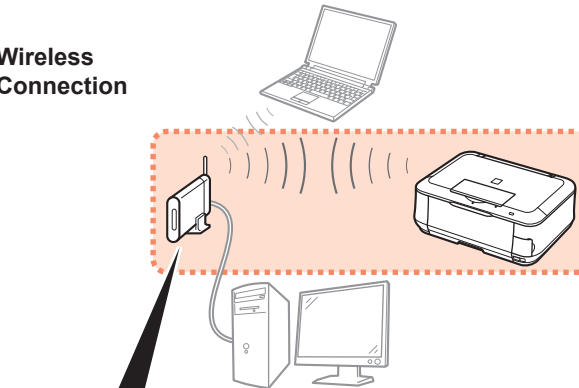

Access point or wireless router

An access point or router that supports IEEE802.11b/g is required.

Wired Connection

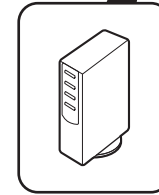
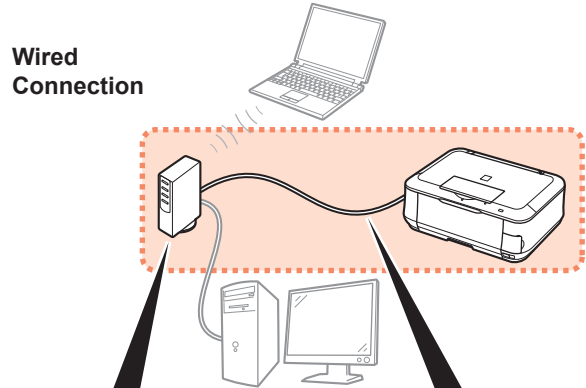

Router, etc.

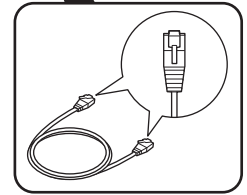

Ethernet cable

A network device (router, etc.) and Ethernet cable are required.

■ Check the Included Items

Before turning on the machine, remove all orange tape and protective sheets from the inside and outside of the machine.

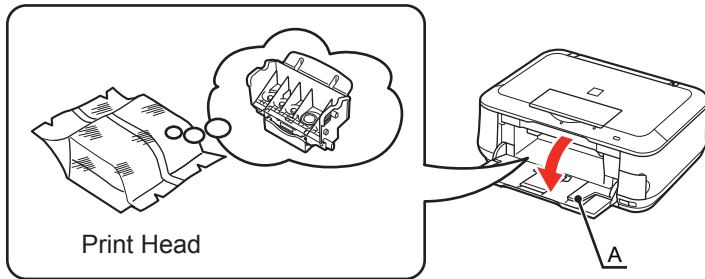

The Print Head is placed inside of the Paper Output Tray (A). Open the Paper Output Tray and take it out.

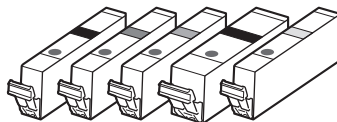

5 ink tanks
(BK, M, C, PGBK, Y)

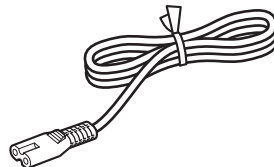

power cord

- Manuals
- Setup CD-ROM (containing the drivers, applications and on-screen manuals)
- Matte Photo Paper MP-101 (for Automatic Print Head Alignment)
- Warranty

□ Choosing a Location



- Do not install the machine where an object may fall on it. The object may fall inside the machine, resulting in malfunction.
- Do not place any object on top of the machine. It may fall into the machine when opening covers, resulting in malfunction.



- A USB cable is necessary to connect the machine with your computer (USB connection only).

Turn the Power On

1

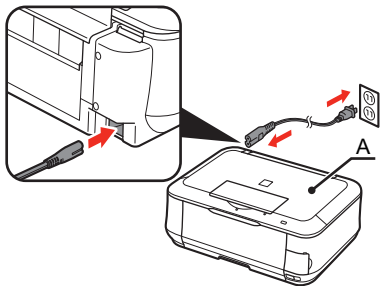

Plug the power cord into the back left of the machine, then connect the other end to the wall outlet.



- Do NOT connect the USB cable or Ethernet cable at this stage.
- Make sure that the Document Cover (A) is closed.

2

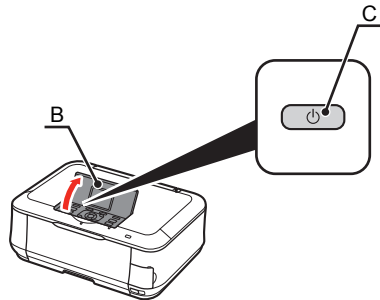

Open the Operation Unit (B) and press the **ON** button (C) to turn on the machine.



- The machine may make some operating noises. This is normal operation.

3

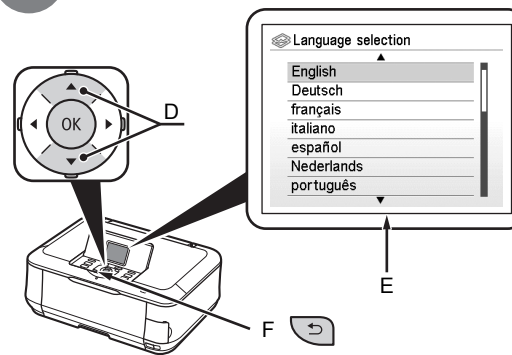

Use the ▲ or ▼ button (D) on the Operation Panel to select the language for the LCD (E), then press the **OK** button.



- If an unintended language is displayed on the LCD, press the **Back** button (F) to return to the **Language selection** screen.

4

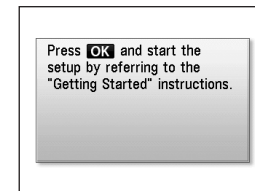

When the above screen is displayed, press the **OK** button and go to the next step.

Install the Print Head

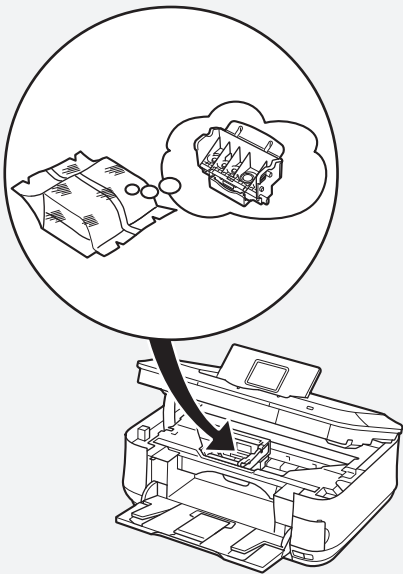

- Handle the Print Head carefully. Do not drop or apply excessive pressure to it.

1

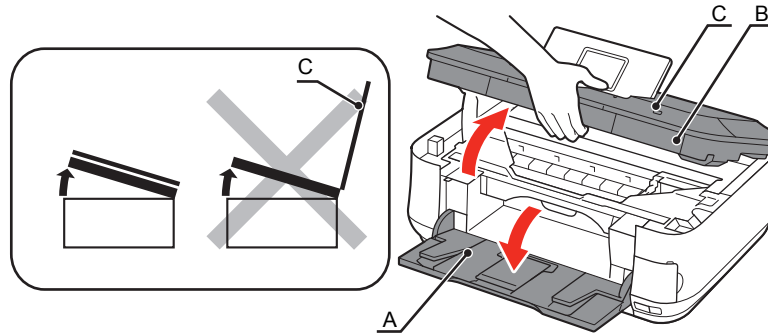

Open the Paper Output Tray (A), then lift the Scanning Unit (Cover) (B) until it stops.

Close the Document Cover (C) and lift it with the Scanning Unit (Cover).

- The Print Head Holder makes a noise as it moves. This is normal operation.
- If the Print Head Holder does not move, make sure that the machine is turned on.

2

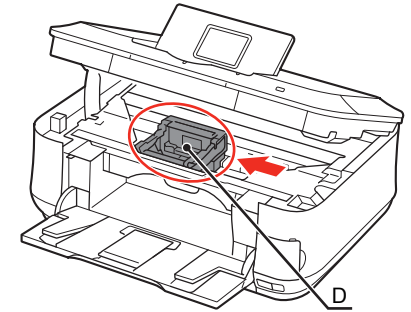

Make sure that the Print Head Holder (D) moves to the installation position.

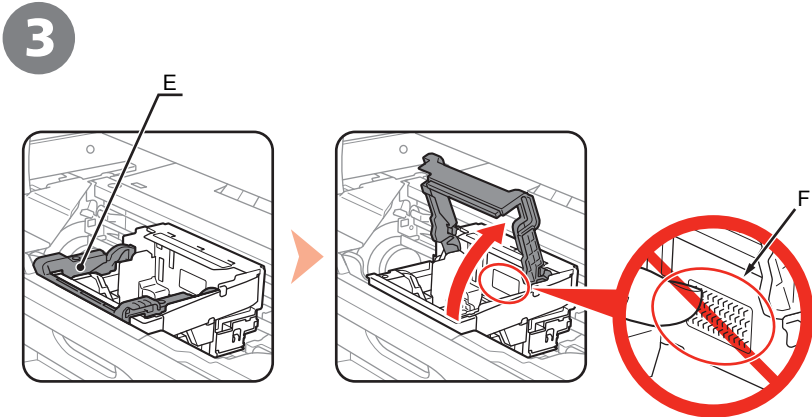

Firmly raise the Print Head Lock Lever (E) of the Print Head Holder until it stops.

- Do not touch the inside of the Print Head Holder (F). The machine may not print properly if you touch it.



Remove the Print Head from the silver package.

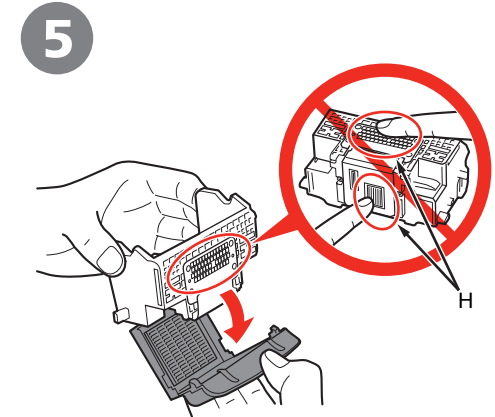

Remove the orange protective cap.

- Do not touch the inside (G) or metal parts (H) of the Print Head. The machine may not print properly if you touch them.
- There may be some transparent or light blue ink on the inside of the bag the Print Head comes in, or the inside of the protective cap - this has no effect on print quality. Be careful not to get ink on yourself when handling these items.

6

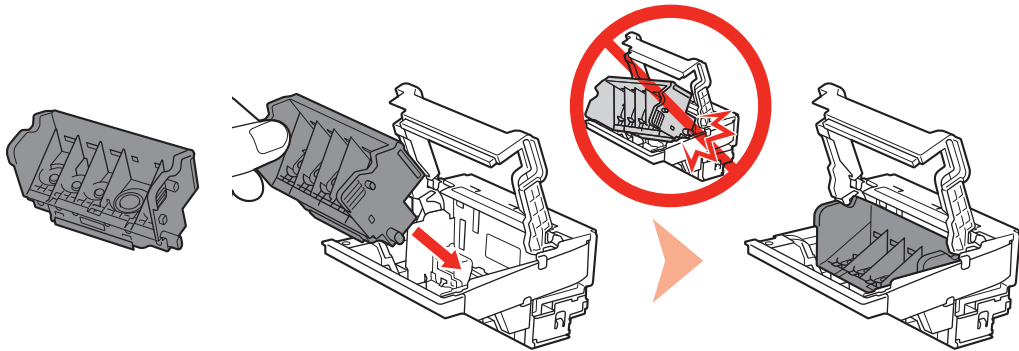

Tilt the Print Head forward and set it in place as shown.

- Do not knock the Print Head against the sides of the holder.
- Install in a well-lit environment.

7

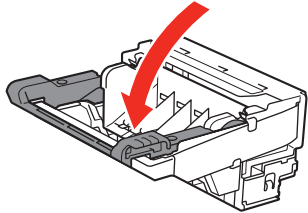

Lower the Print Head Lock Lever completely.

- Hold the Print Head Lock Lever firmly and lower it gently.
- Once you have installed the Print Head, do not remove it unnecessarily.

Install the Ink Tanks

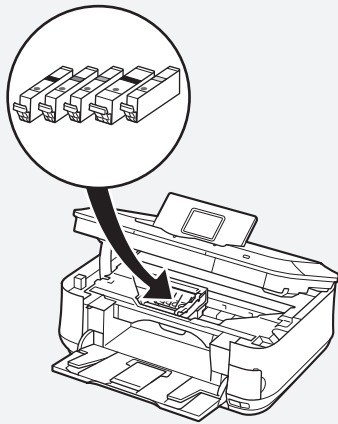

1

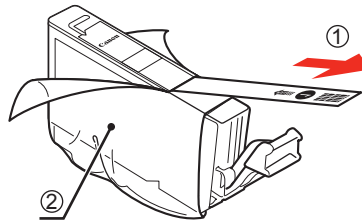

Pull the orange tape (1) in the direction of the arrow to peel off the protective film and remove the film (2) completely.

- Handle the ink tanks carefully. Do not drop or apply excessive pressure to them.
- If the Scanning Unit (Cover) is left open for more than 10 minutes, the Print Head Holder moves to the right. In this case, close and reopen the Scanning Unit (Cover).
- Be sure to use the supplied ink tanks.

2

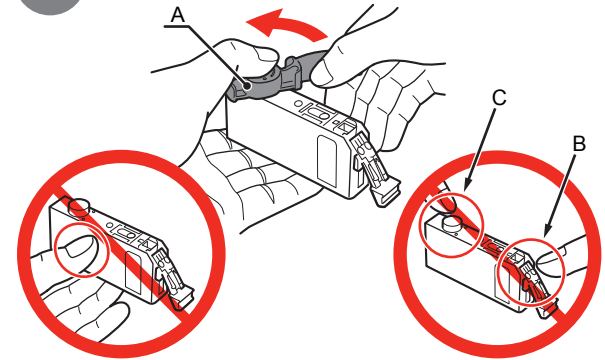

While pressing down with your left thumb, twist off the orange protective cap (A) located on the bottom of the ink tank.

- Do not touch the electrical contacts (B) or open ink port (C) on the ink tank. The machine may not print properly if you touch them.
- Do not push the sides of the ink tank; ink may splash.

3

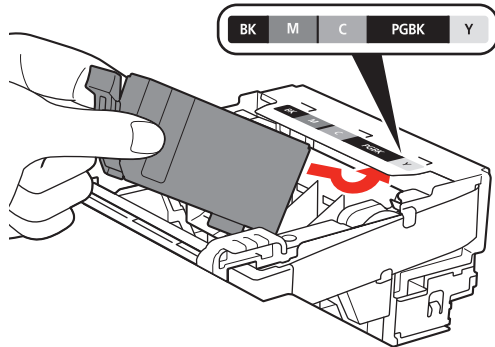

Tilt the ink tank, then insert it under the label and against the back end of the slot.

Make sure that the color of the label matches the ink tank.

- Install in a well-lit environment.

4

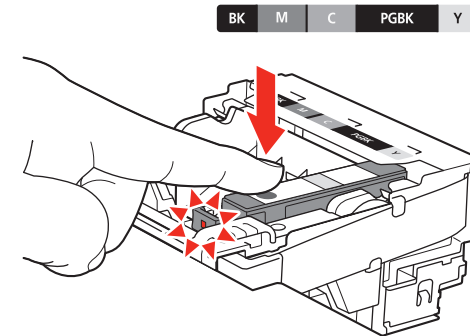

Press the **PUSH** mark on the ink tank firmly until it clicks.

When the installation is completed properly, the **Ink** lamp lights red.



5

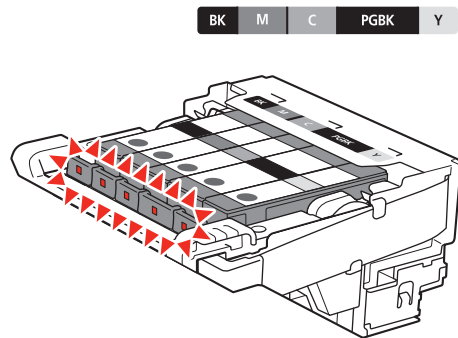

Install all the other ink tanks in the same way.

Install all the ink tanks.

Make sure all the **Ink** lamps light red.

6

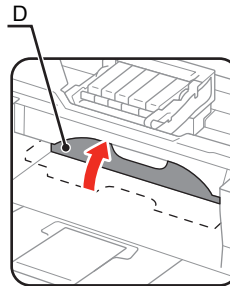

Make sure that the Inner Cover (D) is closed by touching it with your hand.

7

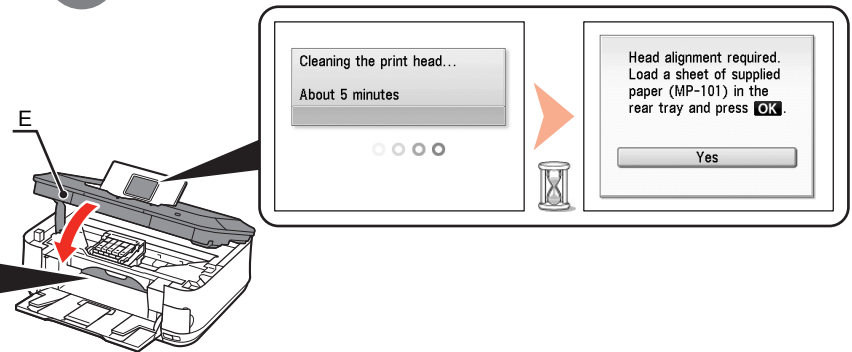

Close the Scanning Unit (Cover) (E).



- Wait until the LCD changes as shown in the illustration (about 5 minutes) and go to the next step.
- The machine may make some operating noises when preparing to print. This is normal operation.



- Once you have installed the ink tanks, do not remove them unnecessarily.



- If an error message is displayed on the LCD, make sure that the Print Head and the ink tanks are correctly installed.

Align the Print Head

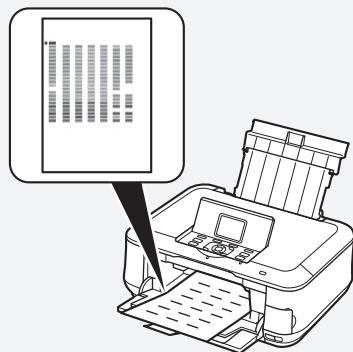

Align the Print Head for better print results.

This takes about 5 minutes.

Use a sheet of supplied specialty paper (**Matte Photo Paper MP-101**) for alignment.

1

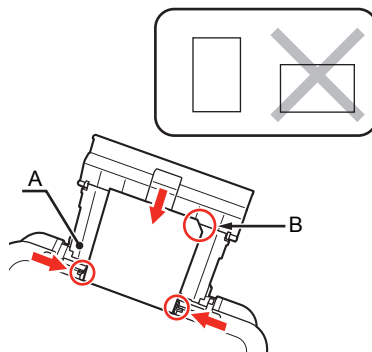

Load a sheet of supplied specialty paper (**Matte Photo Paper MP-101**) in the Rear Tray (A) by referring to steps 7 to 10 in "Loading Paper" on page 49.



- Be sure to use **MP-101** for Automatic Print Head Alignment.
- **MP-101** cannot be fed from the Cassette. Load it in the Rear Tray.
- **MP-101** has front and back sides. Load it so that the cut corner (B) is at the top right.

2

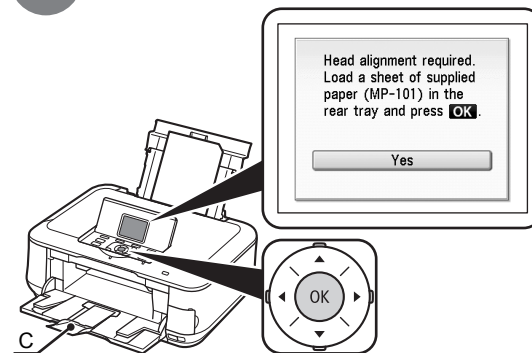

Confirm the message on the LCD and press the **OK** button.

Extend the Output Tray Extension (C).



- Print Head Alignment takes about 5 minutes to complete.
Wait until the pattern is printed, then go to the next step.



- For details on media sizes and types you can use, refer to "Loading Paper" in the on-screen manual: **Basic Guide**.

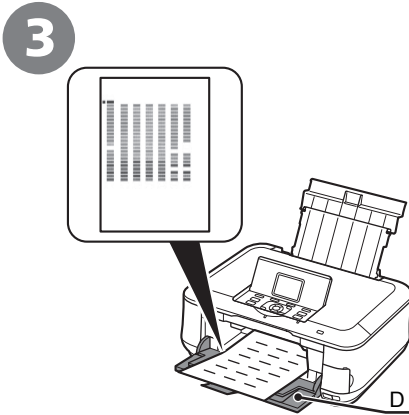

Make sure that a pattern similar to the one shown in the illustration is printed.

Remove the printed paper, then close the Paper Output Tray (D).



- When an error message is displayed on the LCD, press the **OK** button to clear the error, then go to the next step. After the installation is complete, perform Print Head Alignment by referring to "When Printing Becomes Faint or Colors are Incorrect" in the on-screen manual: **Basic Guide**.

- The pattern is printed in black and blue.

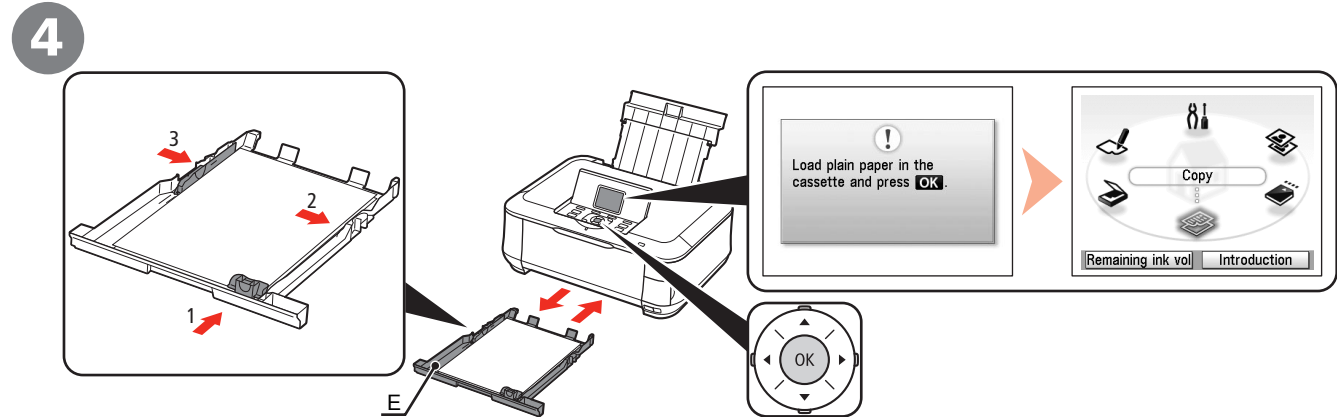

Confirm the message on the LCD, follow the procedure below to load plain paper into the Cassette (E), then press the **OK** button.

- 1 Slide the Paper Guide to align with the actual size of the paper.
- 2 Load paper along the right edge of the Cassette.
- 3 Slide the Paper Guide against the left edge of the paper.

The standby screen is displayed on the LCD.
Print Head Alignment is now complete.



- For details, refer to "Loading Paper" on page 47.

Select Connection Method

Select the method to connect the machine to the computer according to your system environment.

USB Connection

This is the recommended installation when you use the machine on single computer, which is not networked.

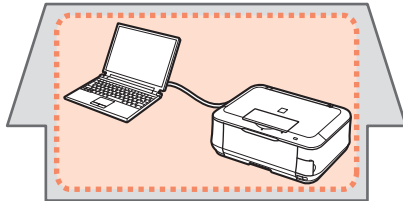

Go to "[USB Connection] Install the Software" on page 14.

Network Connection

This is the recommended installation when you use the machine on a computer connected to a network. Use the machine over a wireless or wired connection.

Connecting the Machine to the Network (Initial Setup)

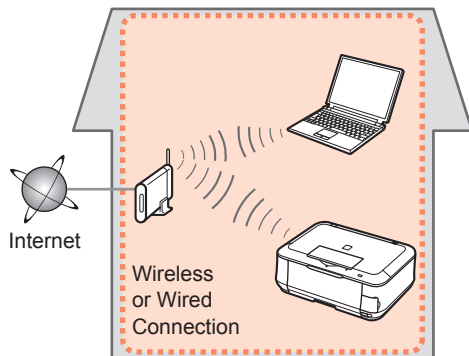

Go to "Select Connection Type" on page 20.

Install the Software

To use the machine by connecting it to a computer, software including the drivers needs to be copied (installed) to the computer's hard disk. The installation process takes about 20 minutes. (The installation time varies depending on the computer environment or the number of applications to be installed.)

The screens below are based on Windows Vista operating system Ultimate Edition (hereafter referred to as "Windows Vista") and Mac OS X v.10.5.x.

For a USB connection, a USB cable is required.

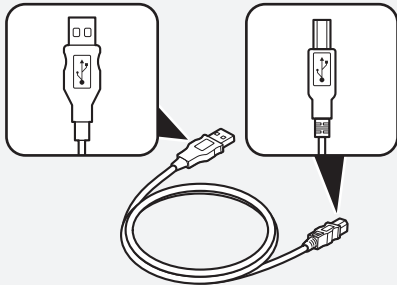

USB cable

- Quit all running applications before installation.
- Log on as the administrator (or a member of the Administrators group).
- Do not switch users during the installation process.
- Internet connection may be required during the installation. Connection fees apply.
- It may be necessary to restart your computer during the installation process. Follow the on-screen instructions and do not remove the **Setup CD-ROM** during restarting. The installation resumes once your computer has restarted.
- Mac OS 9, Mac OS X Classic environments, or Mac OS X v.10.3.8 or earlier are not supported.

Windows

- If the **Found New Hardware** or **Found New Hardware Wizard** dialog box appears:

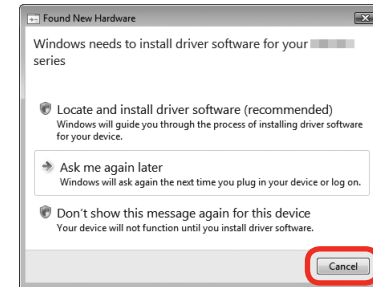

If you connect a USB cable to the machine before installation of the drivers, this screen appears.

- 1 Remove the USB cable connected to your computer.
The dialog box may close. In this case, proceed from ①.
- 2 Click **Cancel** to quit the dialog box.
- 3 Proceed from ①.

Windows

- For Windows Vista/XP

If you are using Internet Explorer 7 or later, you can use the Web print software Easy-WebPrint EX. An internet connection is required for installation. (It is also possible to install this software later.)

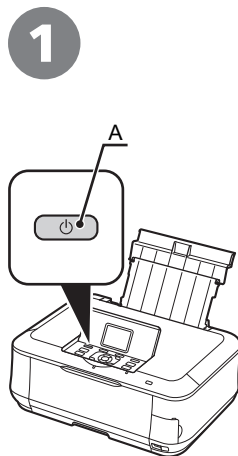

1 TURN OFF THE MACHINE (A).

- Operating noise continues for about 30 seconds until the machine turns off.

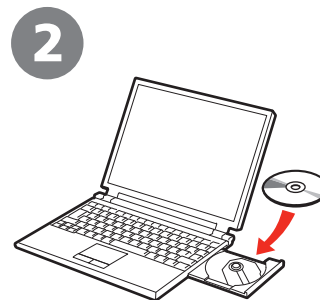

2 Turn on the computer, then insert the **Setup CD-ROM** into the CD-ROM drive.

The setup program will start automatically.



- If the program does not start automatically, double-click the CD-ROM icon in **Computer** or **My Computer**. When the CD-ROM contents appear, double-click **MSETUP4.EXE**.

Macintosh

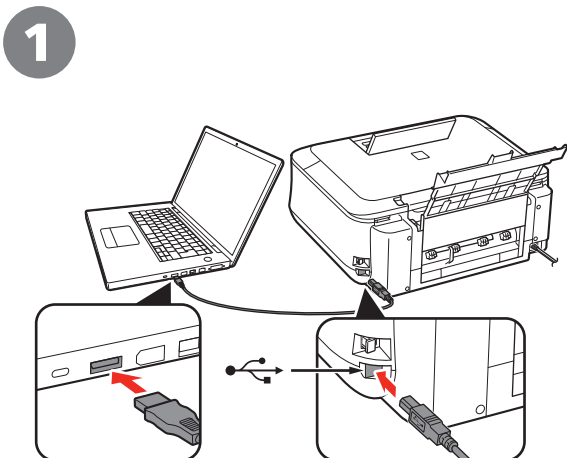

1 Connect the machine to the computer with a USB cable.

Make sure the machine is turned on.



- The USB Port is located on the right side at the back of the machine. The lower port is for USB.

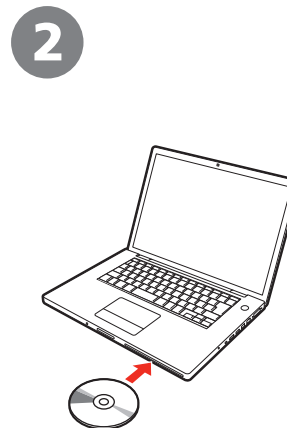

2 Turn on the computer, then insert the **Setup CD-ROM** into the CD-ROM drive.

3 Windows Vista

Windows XP/2000 → 4

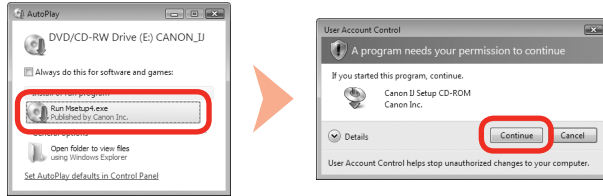

Click **Run Msetup4.exe** on the **AutoPlay** screen, then click **Continue** on the **User Account Control** dialog box.

If the **User Account Control** dialog box reappears in following steps, click **Continue**.

3

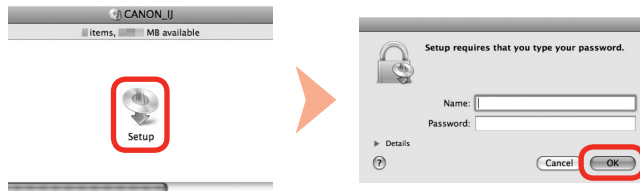

Double-click the **Setup** icon of the CD-ROM folder to proceed to the following screen. Enter your administrator name and password, then click **OK**.

If you do not know your administrator name or password, click **Help**, then follow the on-screen instructions.



- If the CD-ROM folder does not open automatically, double-click the CD-ROM icon on the desktop.



4



Click **Easy Install**.

The drivers, application software, and on-screen manuals are installed all together.



- If you want to select particular items to install, click **Custom Install**.

5

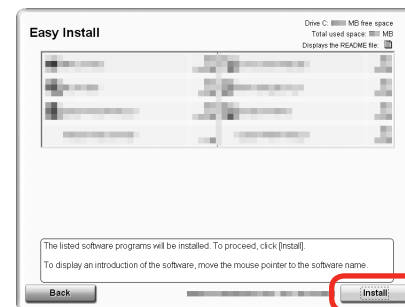

Click **Install**.

For Windows Vista/XP

- If you are using Internet Explorer 7 or later, you can use the Web print software Easy-WebPrint EX. An internet connection is required for installation. (It is also possible to install this software later.)

6

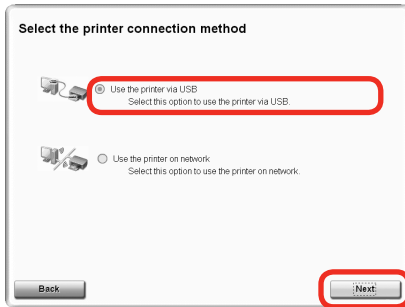

Select **Use the printer via USB**, then click **Next**.

Follow any on-screen instructions to proceed with the software installation.



Important Information for the Installation

□ Necessary Information for the User Registration

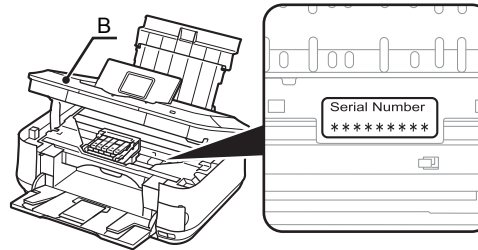

The product serial number is required when registering the product. The serial number is located inside the machine (as shown in the illustration).

- When opening the Scanning Unit (Cover) (B), the Print Head Holder moves automatically.

□ About Extended Survey Program

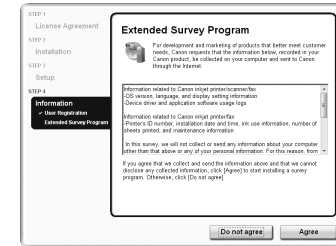

If you can agree to Extended Survey Program, click **Agree**.
If you click **Do not agree**, the Extended Survey Program will not be installed.
(This has no effect on the machine's functionality.)

- The screen does not appear on Mac OS X v.10.3.9.

7

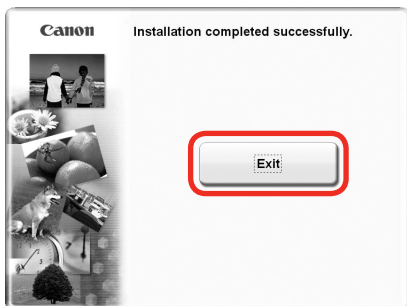

Click **Exit** to complete the installation.

If **Restart** is displayed, follow the instruction to restart the computer.

After restarting the computer, remove the **Setup CD-ROM** and keep it in a safe place.

When using Macintosh, it is necessary to restart the computer before scanning using the Operation Panel on the machine for the first time.

Next, read "Loading Paper" on page 47!

Select Connection Type

Before connecting the machine to the network, make sure that configuration of the computer and access point or router is complete, and that the computer is connected to the network.

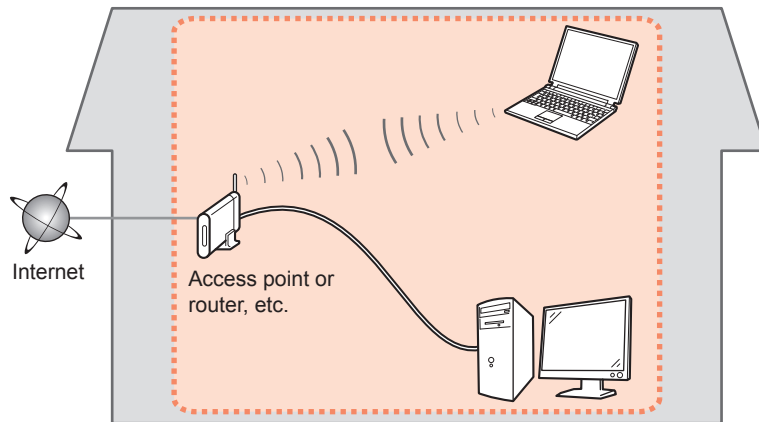

■ Notes on Network Connection

- The configuration, router functions, setup procedures and security settings of the network device vary depending on your system environment. For details, refer to your device's instruction manual or contact its manufacturer.
- In an office setup, consult your network administrator.
- If you connect to a network that is not protected with security measures, there is a risk of disclosing data such as your personal information to a third party.
- The machine cannot be used over a wireless and wired connection at the same time.
- If an error message appears or if you have trouble with the network connection, refer to the printed manual: **Network Setup Troubleshooting**.



- To use the machine on additional computers (after connecting it to the first computer), refer to "[Network Connection] Install the Software" on page 34 and complete setup on those computers.

Select the method to connect the machine to the network.

Wireless Connection

Connect to your network environment over a wireless connection.

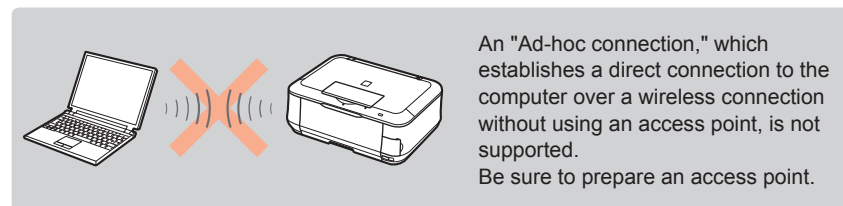
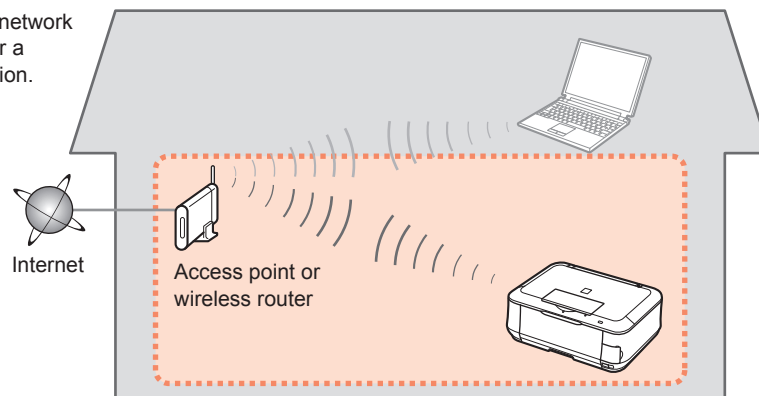

Go to "Wireless Setup" on page 22.

Wired Connection

Connect to your network environment over a wired connection.

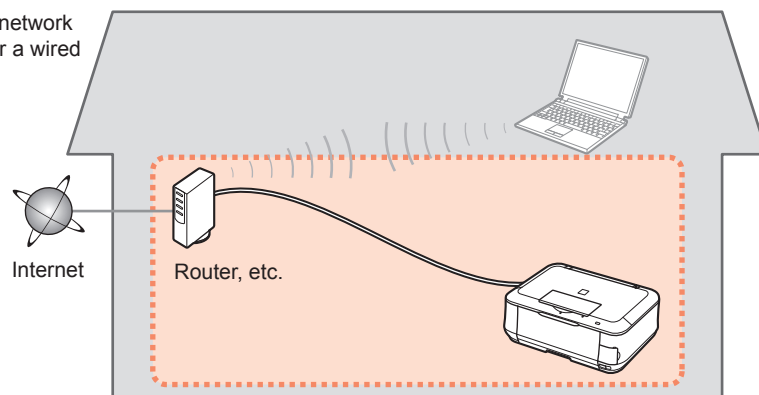

Go to "Wired Setup" on page 29.

Wireless Setup

■ Check the Information for Wireless Connection

The following information is required to connect to your access point or router.
Check your access point or router for the following information, then write it down.

For details on how to check the following information, refer to the manual of your access point or router, or contact its manufacturer.

Access Point Name/Network Name: _____

* Also referred to as SSID.

An identifier to identify the specific access point.

Network Key: _____

* Also referred to as encryption key, WEP key or WPA/WPA2 passphrase, Pre-Shared key.

A password required to set to prevent unauthorized access to communication.

You can retrieve your network key by using the Canon PIXMA Wireless Setup Assistant or the instructions which can be downloaded from the Canon support webpage (www.usa.canon.com/downloadlibrary).

If you are unable to retrieve the network key or other settings, refer to the manual of your access point or router, or contact its manufacturer.

- If your access point or router supports WPS (Wi-Fi Protected Setup):

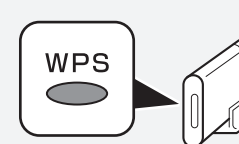

A wireless connection can be set up easily without checking the information to the left. Go to "Wireless Setup Using WPS (Wi-Fi Protected Setup)" on page 26.

For details on WPS, refer to the manual of your access point.



- If you are using Windows Vista operating system and have a USB flash drive, you can configure wireless connection settings by using the WCN (Windows Connect Now) function as well. For details, refer to "Wireless Setup Using WCN (Windows Connect Now)" in "Reference Information" on page 58.

1

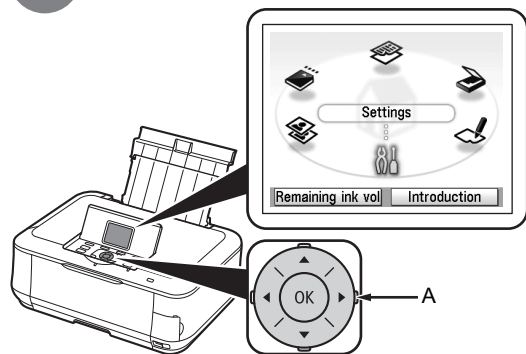

Use the Easy-Scroll Wheel (A) to select **Settings**, then press the **OK** button.

2

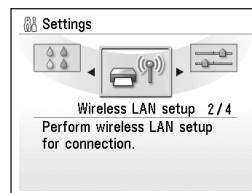

Select **Wireless LAN setup**, then press the **OK** button.

3

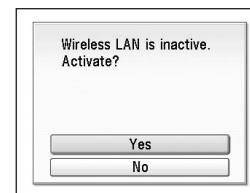

Select **Yes**, then press the **OK** button.

When wireless connection is enabled, the **Wi-Fi** lamp (B) lights blue.

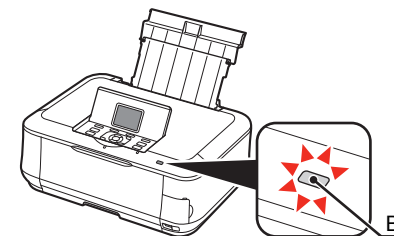

4

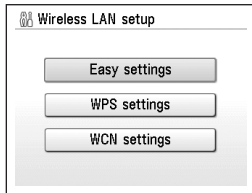

Select **Easy settings**, then press the **OK** button.

5

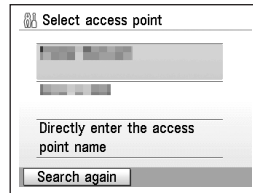

Select the access point name you wrote down on page 22, then press the **OK** button.



- If you are living in an apartment, nearby access points in use may be detected.

6

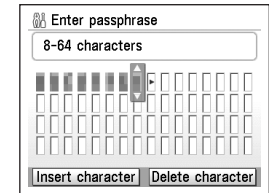
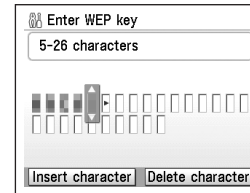

When one of the above screens is displayed, enter the network key you wrote down on page 22, then press the **OK** button.

If the above screen is not displayed, go to step ③.

Use the Easy-Scroll Wheel to select the character. Use the **▶** button to move the cursor to the right.

- Enter upper and lower case letters of the alphabet correctly.

7



Make sure that the network key is correct, then press the **OK** button.

8

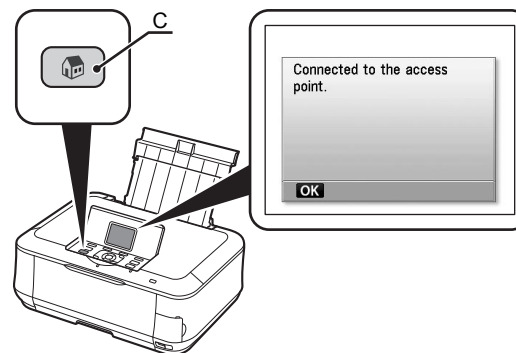

When the completion screen appears, press the **OK** button, then press the **HOME** button (C).

The standby screen returns.



- If **Failed to connect to the access point.** appears, press the **OK** button, make sure that the network key is correct, then enter it again. If a connection still cannot be established, refer to the printed manual: **Network Setup Troubleshooting.**

Next, read "Confirm Connection Status" on page 32!

Wireless Setup Using WPS (Wi-Fi Protected Setup)

1

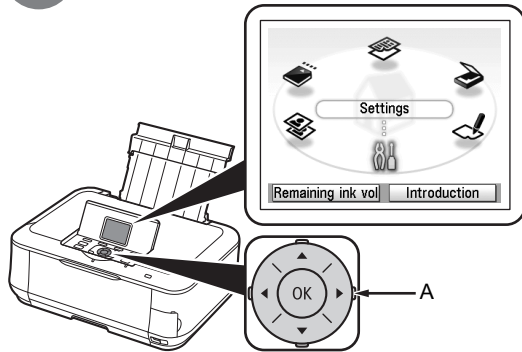

Use the Easy-Scroll Wheel (A) to select **Settings**, then press the **OK** button.

2

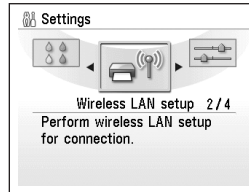

Select **Wireless LAN setup**, then press the **OK** button.

3

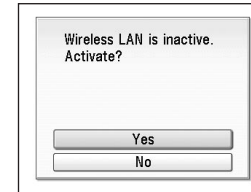

Select **Yes**, then press the **OK** button.

When wireless connection is enabled, the **Wi-Fi** lamp (B) lights blue.

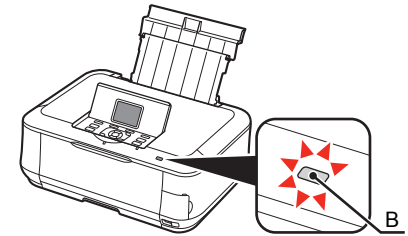

4

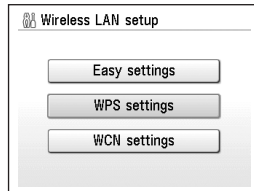

Select **WPS settings**, then press the **OK** button.

5

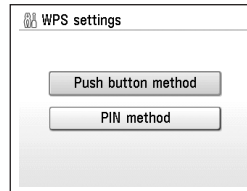

Select **Push button method**, then press the **OK** button.

6

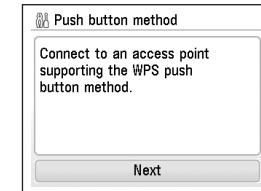

Press the **OK** button.



- To use the PIN code method for setup, select **PIN method** in step 5, then press the **OK** button. Follow the on-screen instructions to operate the machine and access point. When the setup is complete, the completion screen appears. Press the **OK** button to return to the **Settings** screen.
A timeout error occurs if setup is not completed within 10 minutes. If the timeout error screen appears, press the **OK** button, then perform the setup again and set the new PIN code displayed on the screen to the access point. If another error appears, refer to the printed manual: **Network Setup Troubleshooting**.

7

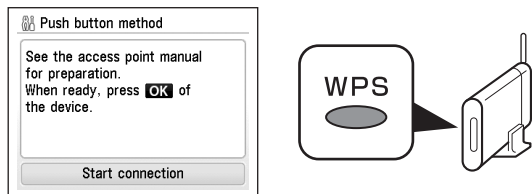

Press and hold the WPS button on the access point (for about 5 seconds), then press the **OK** button on the machine within 2 minutes.

For details on the WPS button pressing, refer to the manual of your access point.

The **Wi-Fi** lamp (blue) flashes while searching for an access point.

8

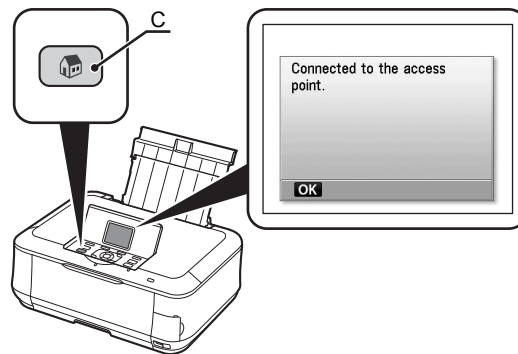

When the completion screen appears, press the **OK** button, then press the **HOME** button (C).

The standby screen returns.

Next, read "Confirm Connection Status" on page 32!

- If the timeout error screen appeared repeatedly, or if another error appeared, refer to the printed manual: **Network Setup Troubleshooting**.

Wired Setup

Connect to the network over a wired connection. A Ethernet cable is required to connect to a network device (router, etc.). Prepare a Ethernet cable.

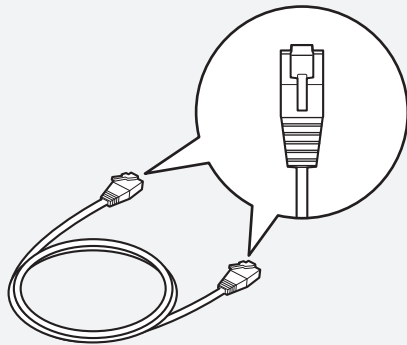

Ethernet cable

1

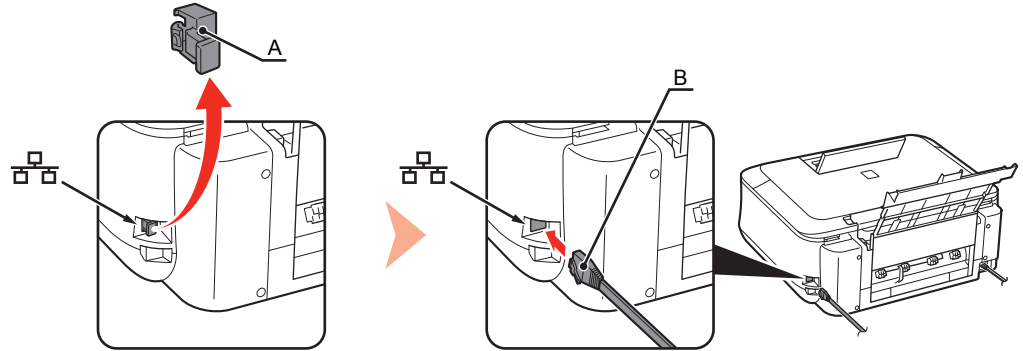

Remove the Cap (A), then connect a network device (router, etc.) with a Ethernet cable (B).



2

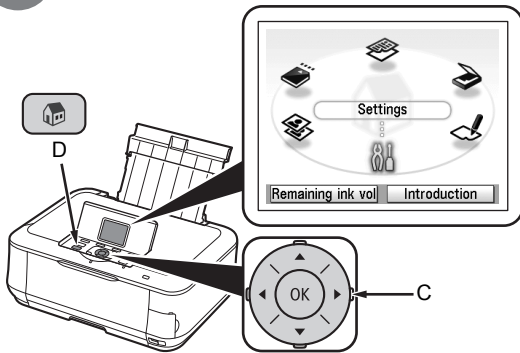

Use the Easy-Scroll Wheel (C) to select **Settings**, then press the **OK** button.

3

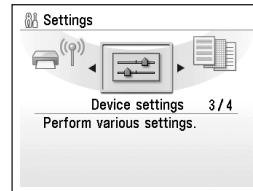

Select **Device settings**, then press the **OK** button.

4

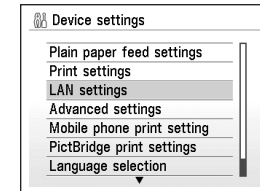

Select **LAN settings**, then press the **OK** button.

5

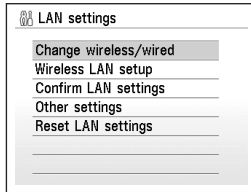

Select **Change wireless/wired**, then press the **OK** button.

6

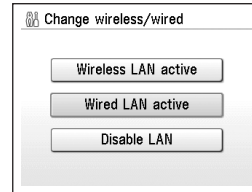

Select **Wired LAN active**, press the **OK** button, then press the **HOME** button (D).

Next, read "Confirm Connection Status" on page 32!

Confirm Connection Status

1

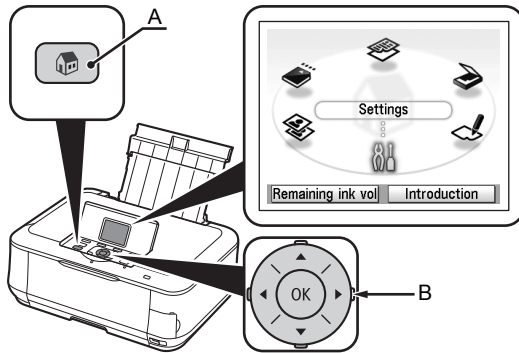

Press the **HOME** button (A), select **Settings** using the Easy-Scroll Wheel (B), then press the **OK** button.

2

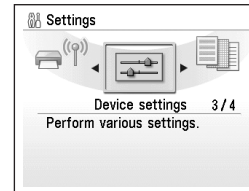

Select **Device settings**, then press the **OK** button.

3

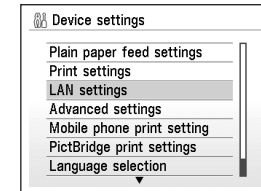

Select **LAN settings**, then press the **OK** button.

- Confirm connection status after installing the machine in the target location.

4

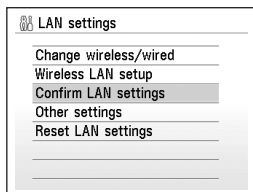

Select **Confirm LAN settings**, then press the **OK** button.

5

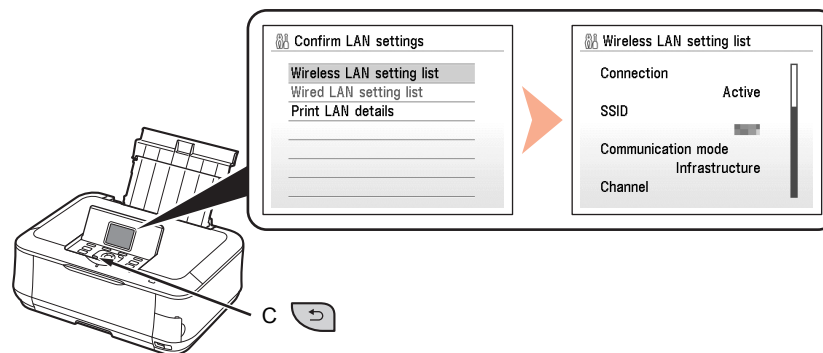

Select **Wireless LAN setting list** or **Wired LAN setting list**, then press the **OK** button.

Make sure that **Connection** is set to **Active**, then press the **HOME** button.

It may take a while before the connection is complete. In this case, press the **Back** button (C) and wait for about a minute, then display the **Wireless LAN setting list** screen or **Wired LAN setting list** screen again.



- If the communication status does not improve, make sure of the following.
 - The machine and network device are turned on.
 - There is no obstacle between the machine and access point, and wireless communication is possible.
 - There is no microwave, refrigerator or any other object that may cause radio interference nearby.
 - For wired connections, the Ethernet cable is connected properly.

Now the machine is connected to the network.
Next, read "[Network Connection] Install the Software" on page 34.

Install the Software

To use the machine by connecting it to a computer, software including the drivers needs to be copied (installed) to the computer's hard disk. The installation process takes about 20 minutes. (The installation time varies depending on the computer environment or the number of applications to be installed.)

The screens below are based on Windows Vista operating system Ultimate Edition (hereafter referred to as "Windows Vista") and Mac OS X v.10.5.x.

- Quit all running applications before installation.
- Log on as the administrator (or a member of the Administrators group).
- Do not switch users during the installation process.
- Internet connection may be required during the installation. Connection fees apply.
- It may be necessary to restart your computer during the installation process. Follow the on-screen instructions and do not remove the **Setup CD-ROM** during restarting. The installation resumes once your computer has restarted.
- If the firewall function of your security software is turned on, a warning message may appear that Canon software is attempting to access the network. If such a warning message appears, set the security software to always allow access.
- Mac OS 9, Mac OS X Classic environments, or Mac OS X v.10.3.8 or earlier are not supported.

Windows

- For Windows Vista/XP

If you are using Internet Explorer 7 or later, you can use the Web print software Easy-WebPrint EX. An internet connection is required for installation. (It is also possible to install this software later.)

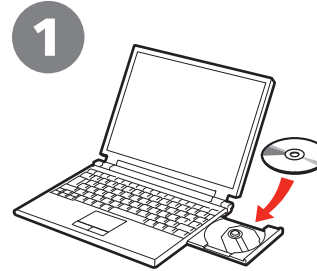

Turn on the computer, then insert the **Setup CD-ROM** into the CD-ROM drive.

The setup program will start automatically.



- If the program does not start automatically, double-click the CD-ROM icon in **Computer** or **My Computer**. When the CD-ROM contents appear, double-click **MSETUP4.EXE**.

Macintosh

1

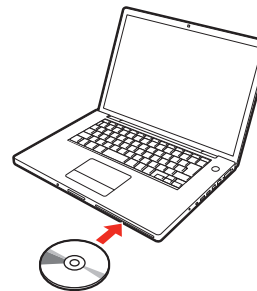

Turn on the computer, then insert the **Setup CD-ROM** into the CD-ROM drive.

2

Windows Vista

Windows XP/2000 → 3

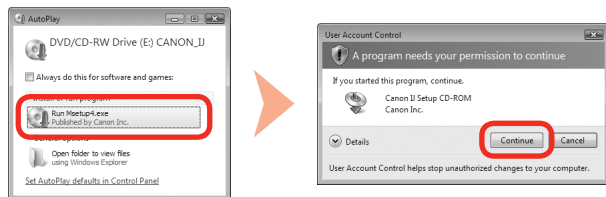

Click **Run Msetup4.exe** on the **AutoPlay** screen, then click **Continue** on the **User Account Control** dialog box.

If the **User Account Control** dialog box reappears in following steps, click **Continue**.

2

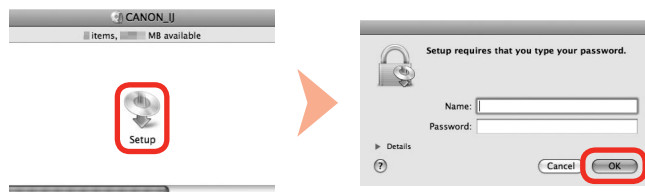

Double-click the **Setup** icon of the CD-ROM folder to proceed to the following screen. Enter your administrator name and password, then click **OK**.

If you do not know your administrator name or password, click **Help**, then follow the on-screen instructions.



- If the CD-ROM folder does not open automatically, double-click the CD-ROM icon on the desktop.

3



Click **Easy Install**.

The drivers, application software, and on-screen manuals are installed all together.



- If you want to select particular items to install, click **Custom Install**.

4

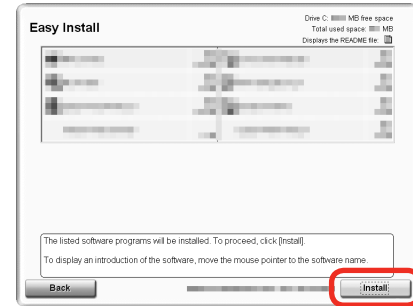

Click **Install**.

For Windows Vista/XP

- If you are using Internet Explorer 7 or later, you can use the Web print software Easy-WebPrint EX. An internet connection is required for installation. (It is also possible to install this software later.)

5

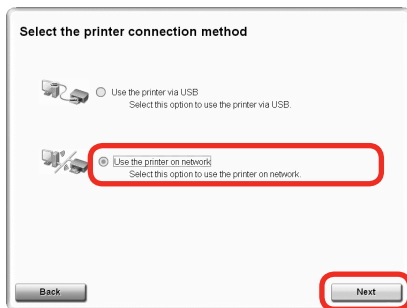

Select **Use the printer on network**, then click **Next**.

6

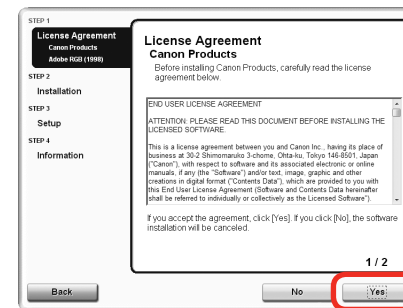

Read the **License Agreement** screen carefully and click **Yes**.

- Follow any on-screen instructions to proceed with the software installation.

Windows

7

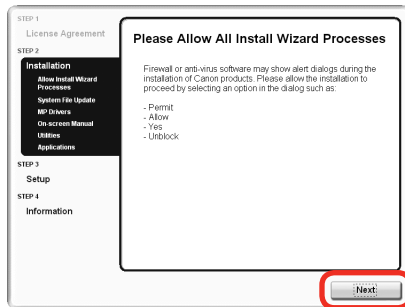

When the **Please Allow All Install Wizard Processes** screen appears, click **Next**.

8

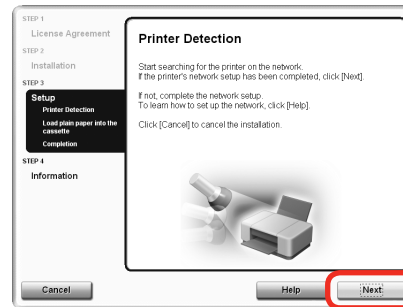

When the **Printer Detection** screen appears, click **Next**.

- If the **Printer Detection** screen is not displayed, the connection method is not correctly selected in step 5. Click **Cancel** and start again from step 4, then be sure to select **Use the printer on network** in step 5.

Macintosh

7

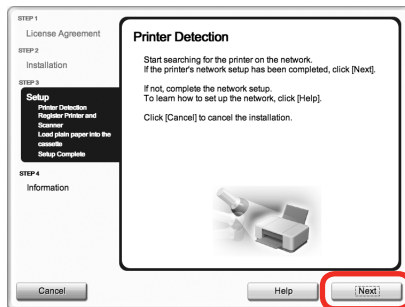

When the **Printer Detection** screen appears, click **Next**.

- If the **Printer Detection** screen is not displayed, the connection method is not correctly selected in step 5. Follow on-screen instructions and proceed with the installation. Click **Exit** on the installation complete screen, then start again from step 2 and be sure to select **Use the printer on network** in step 5.

9

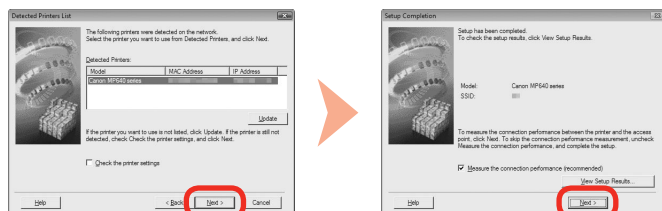

When the **Detected Printers List** dialog box appears, select the machine, then click **Next**.

When the **Setup Completion** dialog box appears, click **Next** or **Complete**.

For Wired Connection → Go to "Install the Software (Information)" on page 45.



- If the machine is not detected, **Check Printer Settings** dialog box is displayed. Refer to the printed manual: **Network Setup Troubleshooting**. Make sure there is no problem, then click **Next** again on the screen in step ⑧.

8

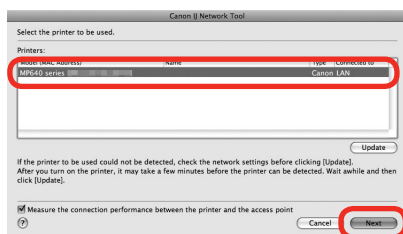

On the **Canon IJ Network Tool** screen, select **MP640 series** in **Printers**, then click **Next**.

For Wired Connection → Go to "Install the Software (Registration)" on page 41.



- If the machine is not detected, refer to the printed manual: **Network Setup Troubleshooting**. Make sure there is no problem, then click **Update**.

10

Wireless Connection

Wired Connection → P.45

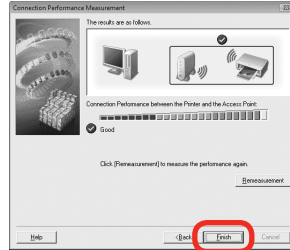
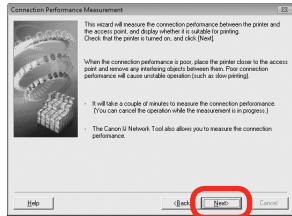

When the **Connection Performance Measurement** dialog box appears, click **Next**.

Confirm the measurement results, then click **Finish**.

Ensure that is displayed in **Connection Performance between the Printer and the Access Point**.



- You can cancel measuring by clicking **Cancel**. You also examine the detailed status of the communication link after setup. For details, refer to the on-screen manual: **Advanced Guide**.
- If an icon other than appears, improve the communication status by referring to the displayed message or the help file, then click **Remeasurement**.

Next, read "Install the Software (Information)" on page 45!

9

Wireless Connection

Wired Connection → P.41

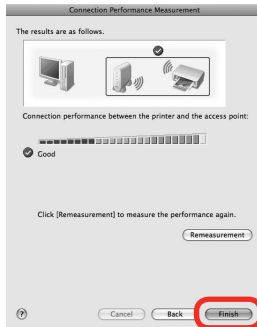
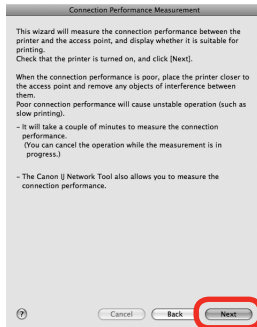

When the **Connection Performance Measurement** screen appears, click **Next**.

Confirm the measurement results, then click **Finish**.

Ensure that is displayed in **Connection performance between the printer and the access point**.



- You can cancel measuring by clicking **Cancel**. You also examine the detailed status of the communication link after setup. For details, refer to the on-screen manual: **Advanced Guide**.
- If an icon other than appears, improve the communication status by referring to the displayed message or the help file, then click **Remeasurement**.

Next, read "Install the Software (Registration)" on page 41!

Install the Software (Registration)

This section describes how to register the machine on a Macintosh computer.

Windows users: read "Install the Software (Information)" on page 45.

1

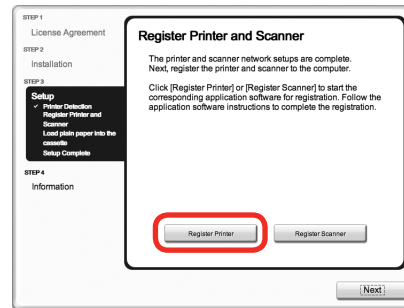

When the **Register Printer and Scanner** screen appears, click **Register Printer**.

- Proceed to the section that relates to your operating system for further installation instructions.

Mac OS X

- v.10.5.x → Go to Step 2 - A.
- v.10.4.x → Go to Step 2 - B.
- v.10.3.9 → Go to Step 2 - C.



- The alphanumeric characters after **Canon MP640 series** is the machine's Bonjour service name or MAC address.
- If the machine has not been detected, make sure of the following.
 - The machine is turned on.
 - The firewall function of any security software is turned off.
 - Wireless Connection: The computer is connected to the access point.
 - Wired Connection: The machine is connected to the network device with the Ethernet cable.

2 - A **Mac OS X v.10.5.x**
Mac OS X v.10.4.x → **2 - B**
Mac OS X v.10.3.9 → **2 - C**

1

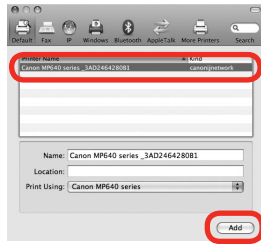

Select **Canon MP640 series** and click **Add**.

➔ Go to Step **3**.

2 - B **Mac OS X v.10.4.x**
Mac OS X v.10.3.9 → **2 - C**

1

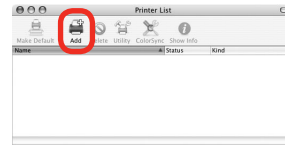

When the **Printer List** window appears, click **Add**.



- When the **You have no printers available.** screen appears, click **Add**.

2

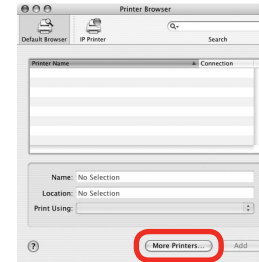

Click **More Printers** in the **Printer Browser** screen.

3

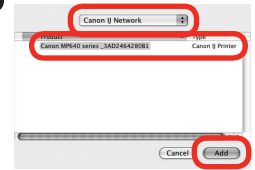

Select **Canon IJ Network** in the pop-up menu, select **Canon MP640 series** in the list of printers, then click **Add**.

2 - C Mac OS X v.10.3.9



4

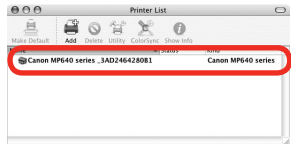

Make sure that **Canon MP640 series** is added to the list of printers.

➔ Go to Step 3.

1



When the **Printer List** window appears, click **Add**.



- When the **You have no printers available.** screen appears, click **Add**.

2

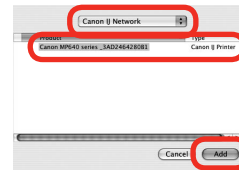

Select **Canon IJ Network** in the pop-up menu, select **Canon MP640 series** in the list of printers, then click **Add**.

3



Make sure that **Canon MP640 series** is added to the list of printers.

➔ Go to Step 3.

3



When the **Register Printer and Scanner** screen appears, click **Register Scanner**.

4

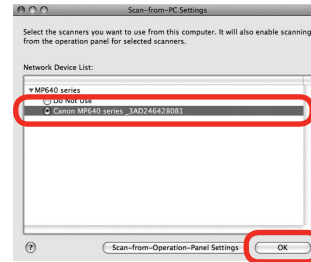

Select **Canon MP640 series** on the **Scan-from-PC Settings** screen, then click **OK**.

5

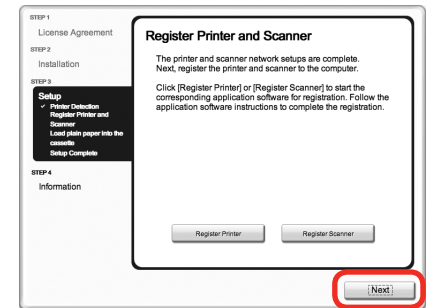

When the **Register Printer and Scanner** screen appears, click **Next**.

Next, read "Install the Software (Information)" on page 45!

Install the Software (Information)

1

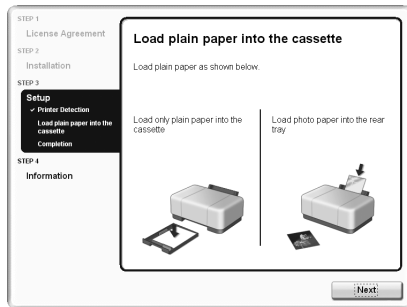

When the **Load plain paper into the cassette** screen appears, follow the on-screen instructions to proceed with the software installation.



- For details, refer to "Loading Paper" on page 47.



Important Information for the Installation

□ Necessary Information for the User Registration

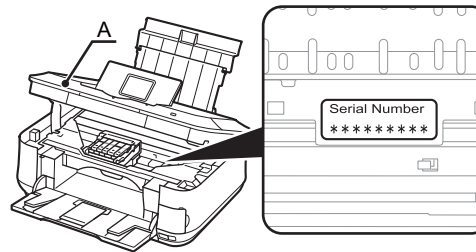

The product serial number is required when registering the product. The serial number is located inside the machine (as shown in the illustration).



- When opening the Scanning Unit (Cover) (A), the Print Head Holder moves automatically.

□ About Extended Survey Program

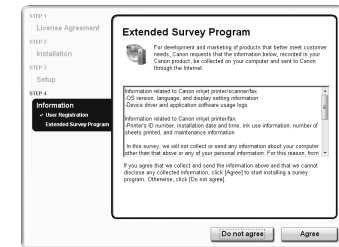

If you can agree to Extended Survey Program, click **Agree**.
If you click **Do not agree**, the Extended Survey Program will not be installed.
(This has no effect on the machine's functionality.)



- The screen does not appear on Mac OS X v.10.3.9.

2



Click **Exit** to complete the installation.

If **Restart** is displayed, follow the instruction to restart the computer.

After restarting the computer, remove the **Setup CD-ROM** and keep it in a safe place.

When using Macintosh, it is necessary to restart the computer before scanning using the Operation Panel on the machine for the first time.

Using the Machine from Additional Computers

Now that the wireless/wired connection of the machine is complete, it can be used from additional computers on the same network.

Install software including the drivers on the computer from which you want to use the machine. Other settings are not required.

For the software installation procedure, refer to "[Network Connection] Install the Software" on page 34.

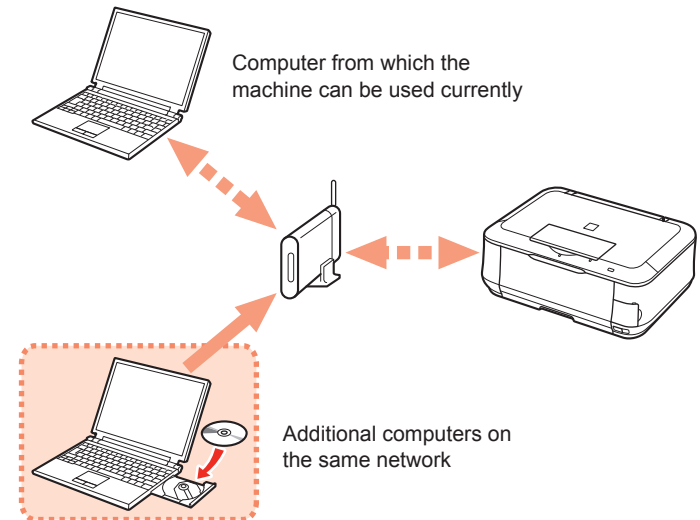

Loading Paper

This section explains how to load paper in the Cassette (A) and the Rear Tray (B).

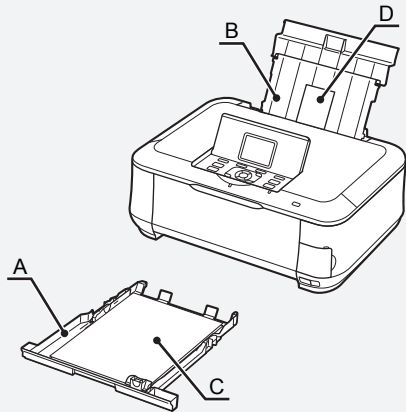

The Cassette supports plain paper (C) only. To print photo paper / Hagaki (D), be sure to load it in the Rear Tray.

1

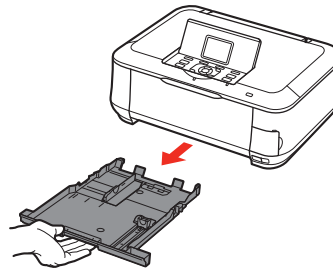

Pull out the Cassette.

2

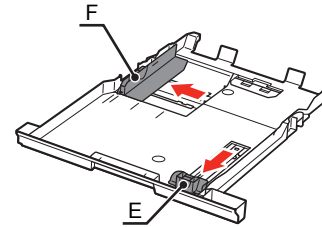

Move the Paper Guides (E) and (F) to both edges.

3

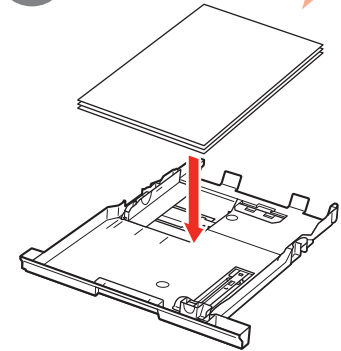

Load plain paper.

Load paper with the printing side facing down.



- To print on specialty paper, be sure to load it in the Rear Tray.

4

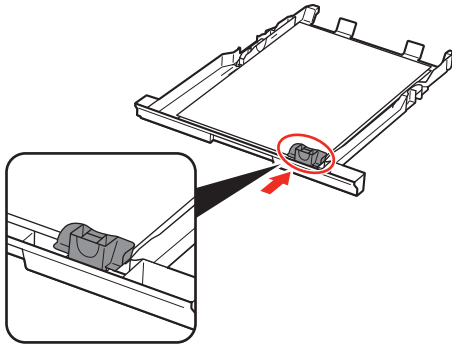

Slide the Paper Guide to align with the actual size of the paper.

The Paper Guide will stop when it aligns with the corresponding mark of paper size.

5

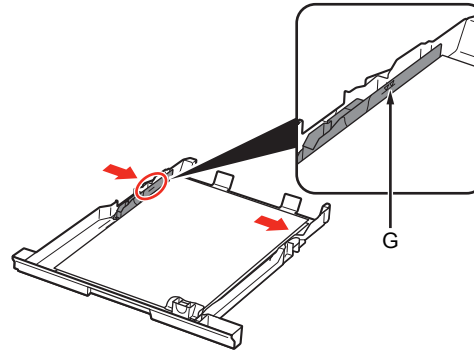

Align the paper with the right edge of the Cassette, then slide the Paper Guide against the left edge of the paper.

Make sure that the paper stack does not exceed the line (G).

6

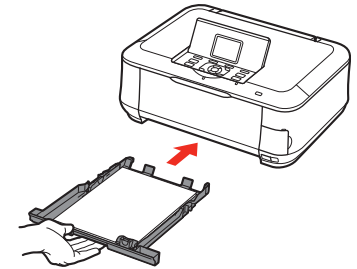

Insert the Cassette slowly into the machine until it clicks into place.



- There may be a little space between the Paper Guide and the paper stack.

7

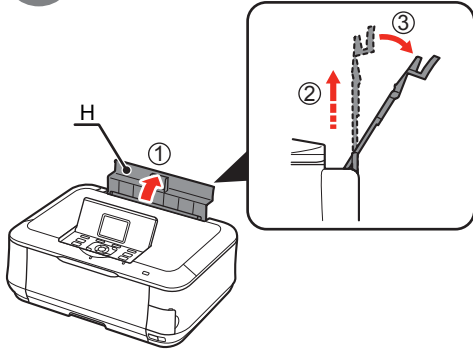

Open the Paper Support (H) and pull it straight up, then slant it back.

8

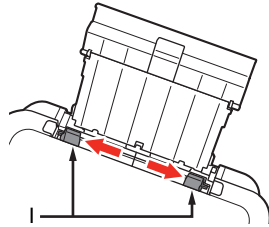

Move the Paper Guides (I) to both edges.

9

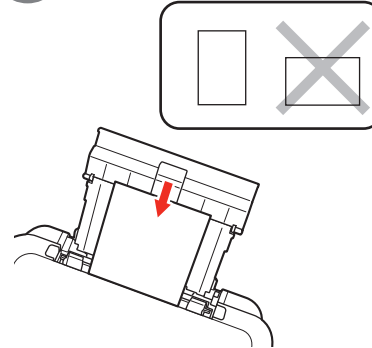

Load paper in the center of the Rear Tray.

Load paper in portrait orientation with the printing side facing up.

10

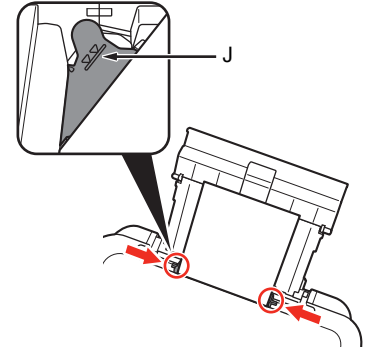

Slide the left and right Paper Guides against both edges of the paper.

Make sure that the paper stack does not exceed the line (J).



- For details on media sizes and types you can use, refer to "Loading Paper" in the on-screen manual: **Basic Guide**.

Preparation for printing is now complete!

Introduction of Manuals

The following manuals are supplied with the machine.

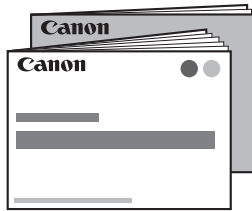

Getting Started (this manual)

Network Setup Troubleshooting

Describes how to set up and use your machine. Introduces the machine and its functions, the included manuals and application software.



Basic Guide

Describes basic operations and media, and gives an introduction to other functions available.



on-screen manuals



Advanced Guide

Describes various operating procedures to make full use of machine.



Troubleshooting

Describes troubleshooting tips for problems you may encounter when using the machine.

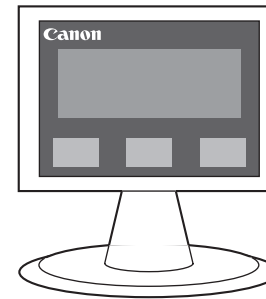

For details on opening the on-screen manuals, refer to page 51.

Solution Menu

Solution Menu is a gateway to functions and information that allow you to make full use of the machine!



Example: Windows Vista

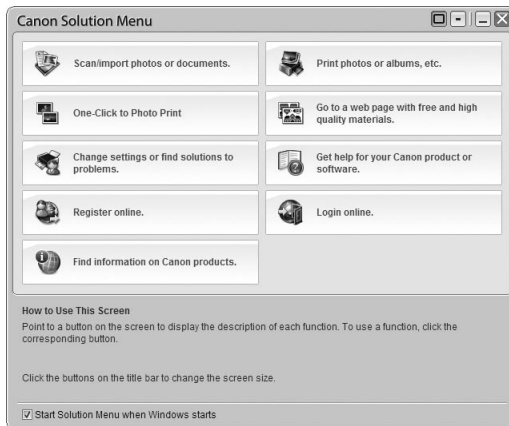

*The buttons displayed vary depending on the country or region of purchase.



Get help for your Canon product or software.

Click this button to open the on-screen manuals.

Open various applications and on-screen manuals with a single click.

You can start Solution Menu from the **Canon Solution Menu** icon on the desktop (Windows) or on the Dock (Macintosh).

If you have a problem with machine settings, click the **Change settings or find solutions to problems.** in Solution Menu to open My Printer (Windows only).

Try Using the Machine

Various application software are installed on the computer along with the drivers. You can print creative items by correcting/enhancing photos using the applications.

Alternatively, use the Operation Panel on the machine to print your own items easily.

For details on how to use the application software and the machine, refer to the on-screen manuals: **Basic Guide** and **Advanced Guide**.













Print Photos from a Memory Card

Print images saved on a memory card used with digital cameras, etc.

For more information on printing from a memory card, refer to "Printing from a Memory Card" in the on-screen manual: **Basic Guide**.

Supported Memory Cards (Adapter required for .)

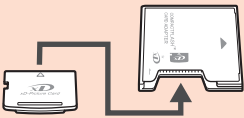
Memory Stick Duo Memory Stick PRO Duo		➔	
Memory Stick Micro			
Memory Stick Memory Stick PRO		➔	
SD Card SDHC Card MultiMediaCard MultiMediaCard Plus			
miniSD Card miniSDHC Card			
microSD Card microSDHC Card			
RS-MMC		➔	
Compact Flash Card* Microdrive			
*TYPE I / TYPE II (3.3V) xD-Picture Card xD-Picture Card Type M xD-Picture Card Type H			

You can also print from USB flash drives. For details, refer to "Printing from a Memory Card" in the on-screen manual: **Basic Guide**.

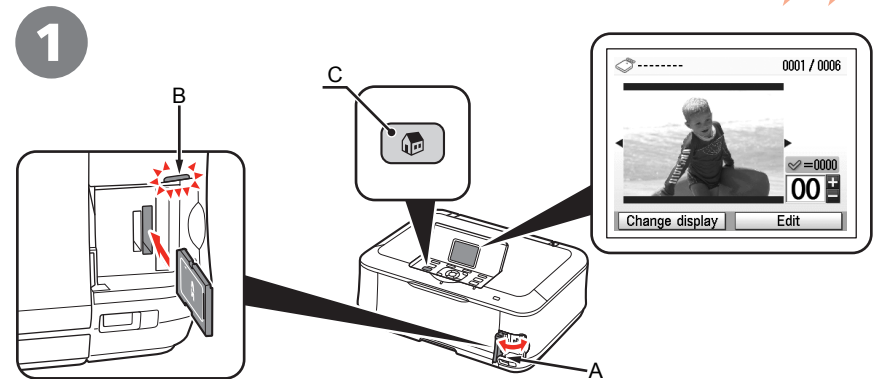

While the standby screen appears, open the Card Slot Cover (A), insert a memory card into the Card Slot.

Insert a memory card into the slot, then close the Card Slot Cover.

Make sure that the **Access** lamp (B) has lit up. After the photos on the memory card are read, the screen to specify photos and the number of copies to print appears.

- Insert a memory card into the Card Slot in the direction of the arrow on the label, with the labeled side facing left.
- Insert only one memory card.



- Press the **HOME** button (C) to return to the standby screen.

2

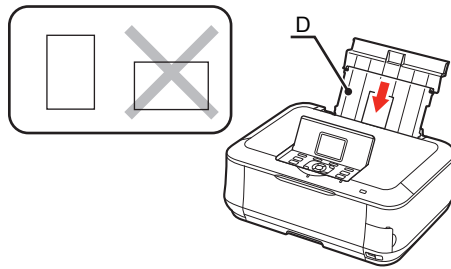

Load a sheet of 4" x 6" size photo paper in the Rear Tray (D) in portrait orientation.

Load paper with the printing side facing up.

3

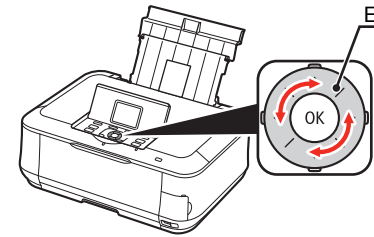

Rotate the Easy-Scroll Wheel (E) to display a photo to print.

Alternatively, use the ◀ or ▶ button to select a photo.



• For details, refer to "Loading Paper" on page 47.

4

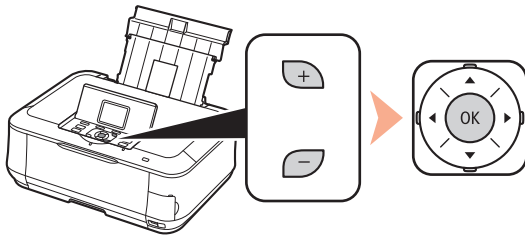

Press the **[+]** or **[-]** button to specify the number of copies, then press the **OK** button.

The Print Settings Confirmation Screen appears.

5

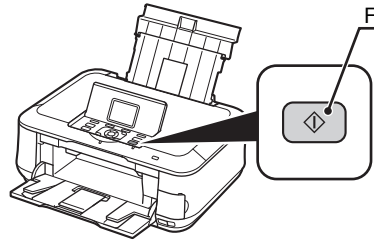

Press the **Color** button (F).

Printing will start.

6

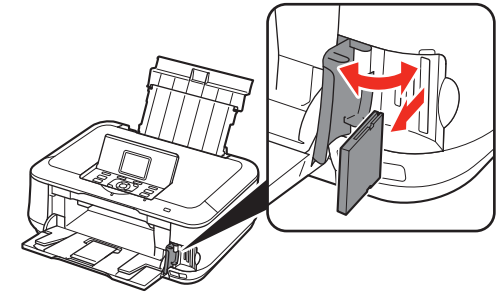

After printing, open the Card Slot Cover, pinch the memory card and pull it straight out.

After removing the memory card, close the Card Slot Cover.



- Do not remove the memory card while the **Access** lamp is flashing. Saved data may be damaged.

Try Copying

You can copy a document by simply placing it on the Platen Glass and pressing the start button.

This section explains with plain paper. For various copying procedures, refer to "Copying" in the on-screen manual: **Basic Guide**.

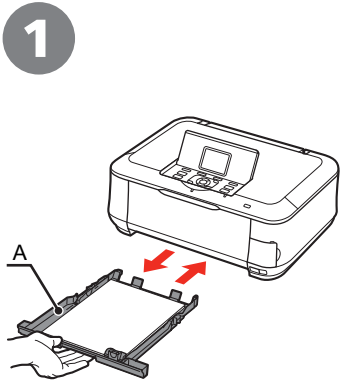

Load A4 or Letter-sized plain paper into the Cassette (A).

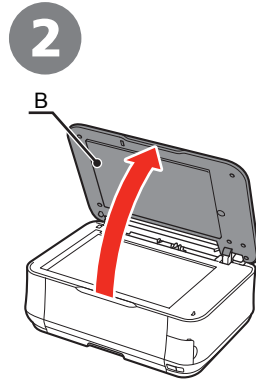

Open the Document Cover (B).

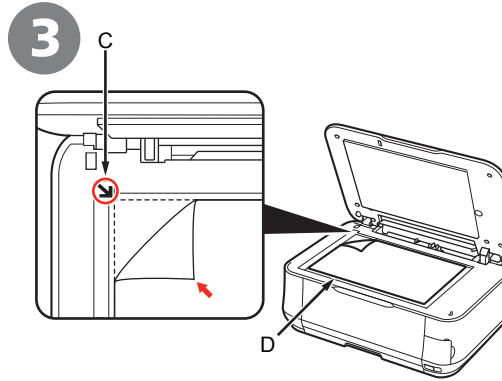

Place the document face-down and align it with the Alignment Mark (C).

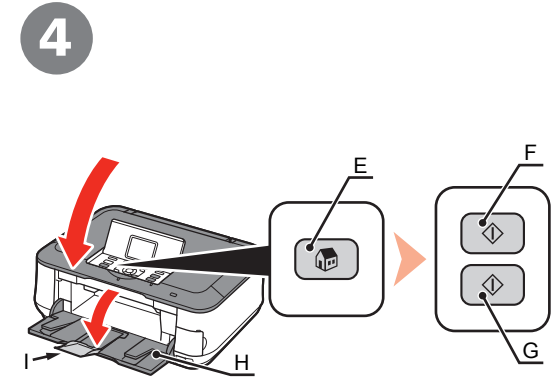

Close the Document Cover, press the **HOME** button (E), then press the **Black** button (F) twice or the **Color** button (G) twice.

When the Paper Output Tray (H) opens automatically, extend the Output Tray Extension (I).

Copying will start. Remove the document after printing.



• For details, refer to "Loading Paper" on page 47.



• Do not place objects weighing 4.4 lb / 2.0 kg or more on the Platen Glass (D), or do not apply pressure to the document by pressing on it with a force exceeding 4.4 lb / 2.0 kg. The scanner may malfunction or the glass may break.



• Do not open the Document Cover until copying is complete.

Print Photos from a Computer

Easy-PhotoPrint EX allows you to print photos easily.

This section explains how to print borderless photos using 4" x 6" size **Photo Paper Plus Glossy II**. The screens are based on Windows Vista.

1

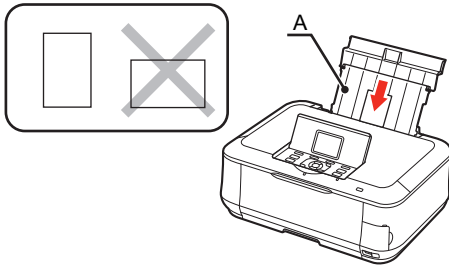

Load a sheet of photo paper in the Rear Tray (A) in portrait orientation.

Load a sheet of paper with the printing side facing up.

2



Start Solution Menu from the icon on the desktop (Windows) or on the Dock (Macintosh), then click **One-Click to Photo Print**.

Easy-PhotoPrint EX starts.

3

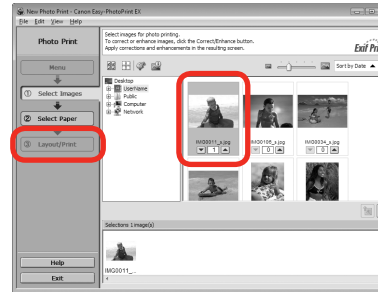

Select the image you want to print, then click **Layout/Print**.

When a photo is selected, the number of copies is set to "1".

4

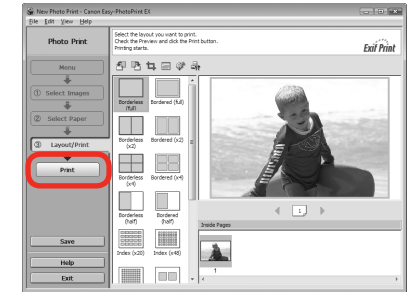

Click **Print**.

For Windows:
Printing will start.

For Macintosh:
Click **Print** on the **Print** dialog box to start printing.



- For details, refer to "Loading Paper" on page 47.



- For details on starting Solution Menu, refer to "Solution Menu" on page 51.
- For more information, refer to the on-screen manual: **Advanced Guide**.

Wireless Setup Using WCN (Windows Connect Now)

Set up a wireless connection by using the WCN (Windows Connect Now) function of Windows Vista.

- Before setting up by using the WCN, establish wireless communication between the computer and the access point.
- Canon assumes no responsibility for any damage or loss of data stored on your USB flash drive regardless of the cause even within the warranty period.
- If your USB flash drive cannot be attached to the Direct Print Port of the machine, a commercial extension cord (for USB flash drives) may be required.
- Operation may not be guaranteed depending on your USB flash drive.
- USB flash drives with security enabled may not be used.



- The machine supports "WCN-UFD".

1

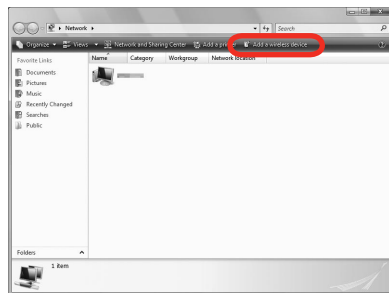

From the **Start** menu of the Windows side, click **Network**.

The **Network** folder opens.

2

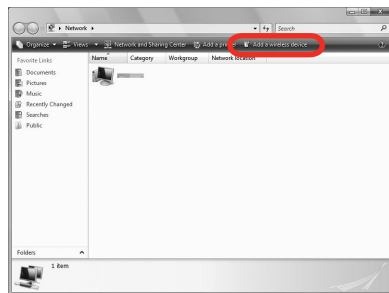

Click **Add a wireless device** on the menu.

The **Add a wireless device to the network** screen will be displayed.

3

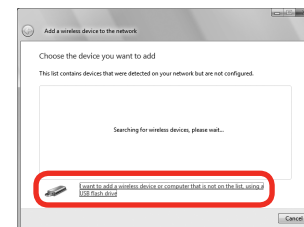

Click **I want to add a wireless device or computer that is not on the list, using a USB flash drive**.

4

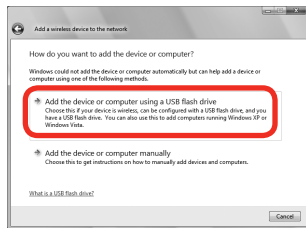

Click **Add the device or computer using a USB flash drive**.

5

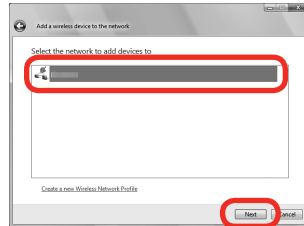

From the list, select the network name (SSID), then click **Next**.



- If the **User Account Control** dialog box appears, click **Continue**. If the same dialog box reappears in subsequent steps, click **Continue**.

6

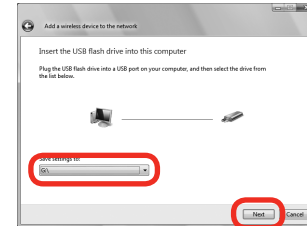

Connect the USB flash drive to the computer, make sure that the drive name is displayed, then click **Next**.

7

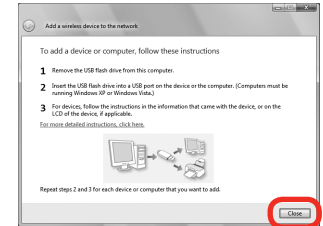

When the above screen appears, remove the USB flash drive from the computer, then click **Close**.

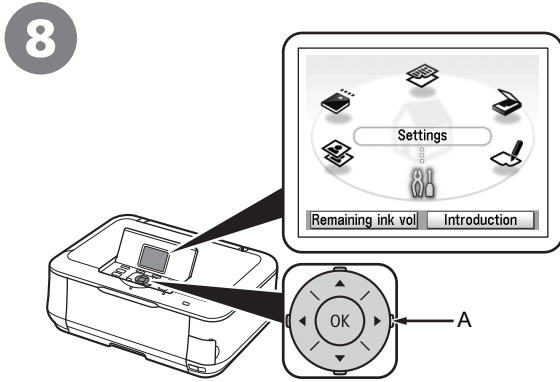

Use the Easy-Scroll Wheel (A) to select **Settings**, then press the **OK** button.

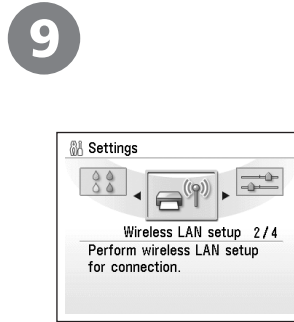

Select **Wireless LAN setup**, then press the **OK** button.

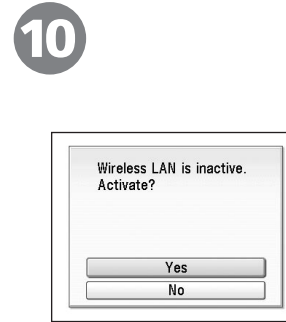

Select **Yes**, then press the **OK** button.
When wireless connection is enabled, the **Wi-Fi** lamp (B) lights blue.

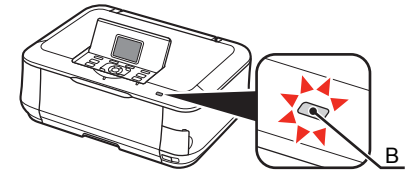

11

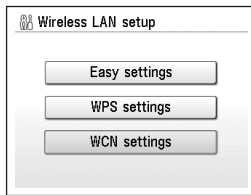

Select **WCN settings**, then press the **OK** button.

12

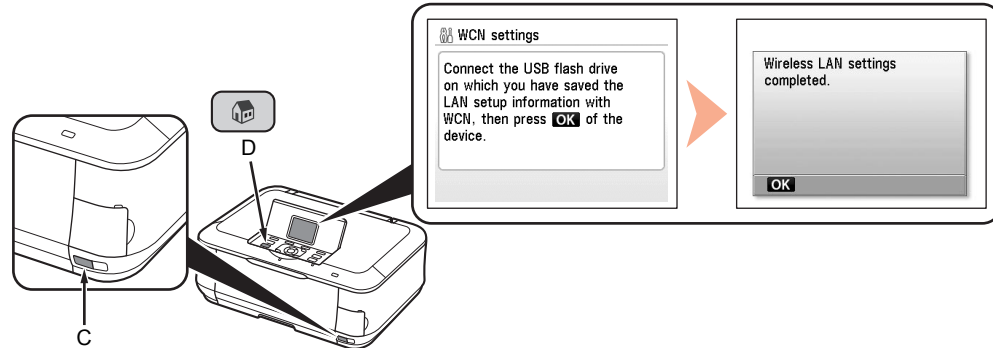

Connect the USB flash drive to the Direct Print Port (USB connector) (C) on the front of the machine, then press the **OK** button.

When the completion screen appears, press the **OK** button, then press the **HOME** button (D). The standby screen returns. Remove the USB flash drive from the machine.

Next, read "Confirm Connection Status" on page 32!

Getting Help from Canon

Email Tech Support — www.canontechsupport.com

Toll-Free Live Tech Support— (1-800-828-4040) under warranty

This option provides live telephone technical support, free of service charges,

Monday-Friday (excluding holidays), during the warranty period.

Telephone Device for the Deaf (TDD) support is available at (1-866-251-3752).

Ordering Information

The following ink tanks are compatible with this machine.



Order

CLI-221BK	2946B001
CLI-221M	2948B001
CLI-221C	2947B001
PGI-220BK	2945B001
CLI-221Y	2949B001

Call 1-800-OK-CANON to locate a dealer near you, or visit the Canon eStore at www.canonstore.com

CANON U.S.A. INC.

One Canon Plaza, Lake Success, NY 11042 U.S.A.

www.usa.canon.com